



Welcome Pack

Madrid

#MiCasaEsSuCasa

A world map in a light blue color is the background. A dark blue location marker, consisting of a circle with a dot in the center, is placed over the Iberian Peninsula, specifically over Spain. The text is overlaid on the map.

Here you can find useful information

Madrid Training Center

Meet our AFG Management Team

AFG is supported by a Management Team that has decades of flight training experience in this industry. They are experienced aviation training executives with a proven track record of success in the management and operations of simulation training facilities worldwide.



ALEJANDRA MIRANDA
Director of Operations-Customers
EUROPE



TANIA MORENO
Training Center
Coordinator

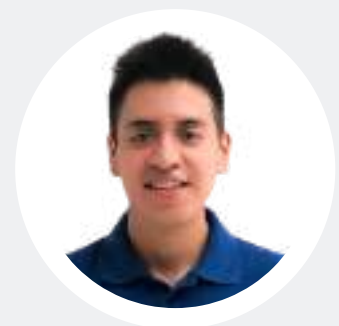

ALONSO AUQUI
Simulator
Maintenance
Team Lead

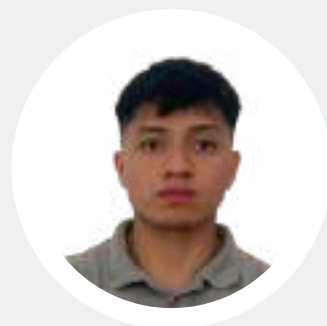

ALAN ANALUISA
Simulator
Maintenance
Technician

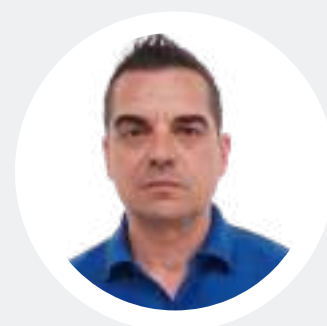

CARLOS PÉREZ
Simulator
Maintenance
Technician

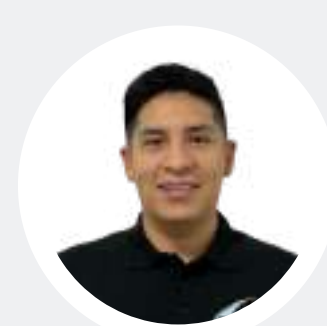

EDUARDO FERNÁNDEZ
Simulator
Maintenance
Technician

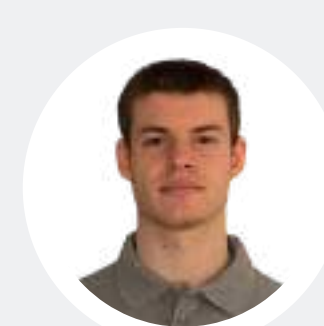

IAN SOLÉ
Simulator
Maintenance
Technician

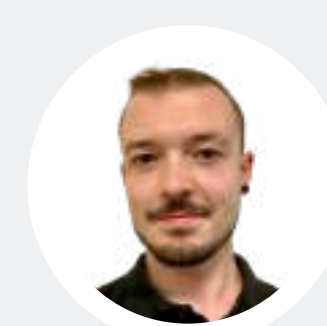

IVÁN MORENO
Simulator
Maintenance
Technician

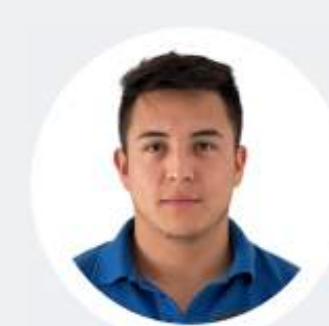

ROGER GONZAGA
Simulator
Maintenance
Technician

The image shows the interior of a training center. In the foreground, there is a blue and white checkered carpet. In the background, a large glass wall reflects the sky and the silhouettes of aircraft. The logo for AFG Avenger Flight Group is prominently displayed on the glass. The logo consists of a stylized blue and white winged figure on the left, followed by the text 'AFG' in large, bold, blue letters, and 'Avenger Flight Group' in smaller, blue letters below it.

AFG Avenger Flight Group

Get to Know our Training Center

- The MAD Training Center opened in 2019 near Barajas International Airport and has three Airbus Full-Motion Flight Simulators (A320, A330 CEO & NEO and A330 CEO), one Boeing Full-Motion Full Flight Simulator (B737) as well as Cabin Emergency Evacuation Trainers and Door Trainers for both types of aircrafts.
- Each of these state-of-the-art flight simulators are certified by AESA.
- We provide an excellent and efficient 24/7 customer service.
- Our facilities are open to all airlines and ATOs worldwide.

Training Center Facilities

Full Flight Simulators (FFS)

- (1) Airbus A320 FFS Level D CEO
- (1) Airbus A330 FFS Level D CEO/NEO
- (1) Airbus A330 FFS Level D CEO
- (1) Boeing B737 NG FFS Level D



Map

MAIN ENTRANCE
Ground floor

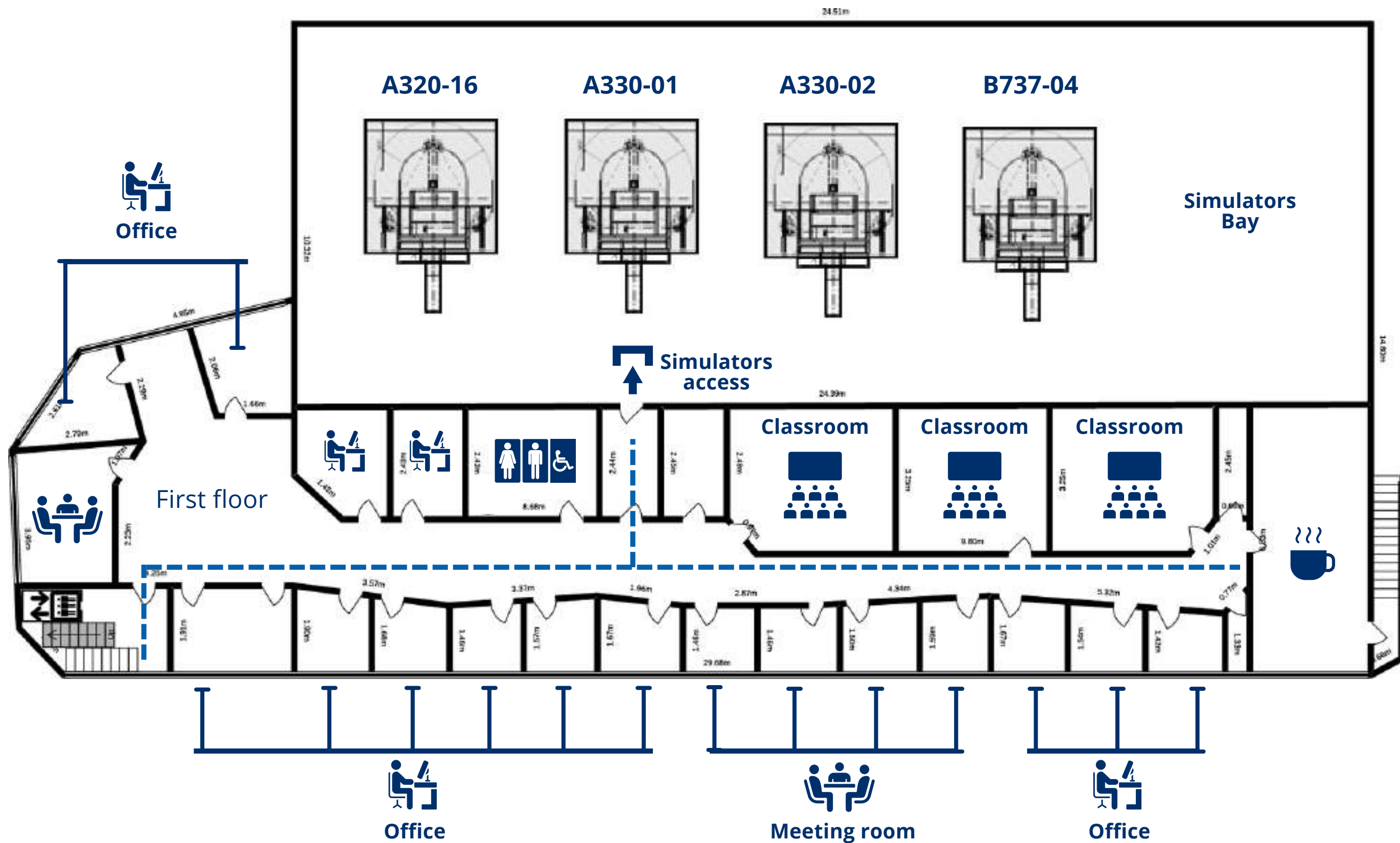
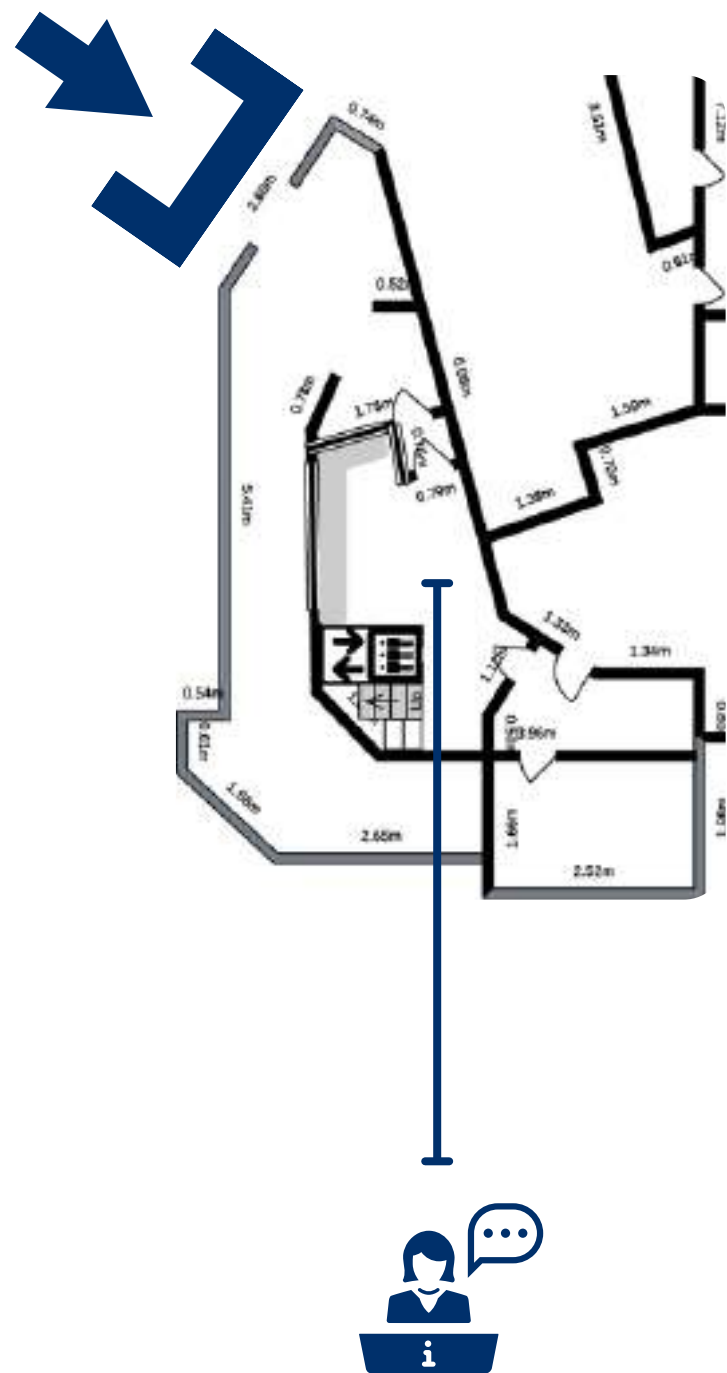

How to Get to the Training Center



From Madrid airport

AFG Training Center is located just 10 km away from Barajas Airport. In the airport you can easily take a taxi or ask for uber or cabify, the trip will cost you approximately €10.

AFG can help organize transfer from the airport for you, just let us know about your arrival two days in advance.



From Madrid city center

From the city center metro Line 5 until "Canillejas" station. In front of the metro exit bus num.77 until "Yécora - Invierno" stop 500 meters (6 min walk) till the Training Center.

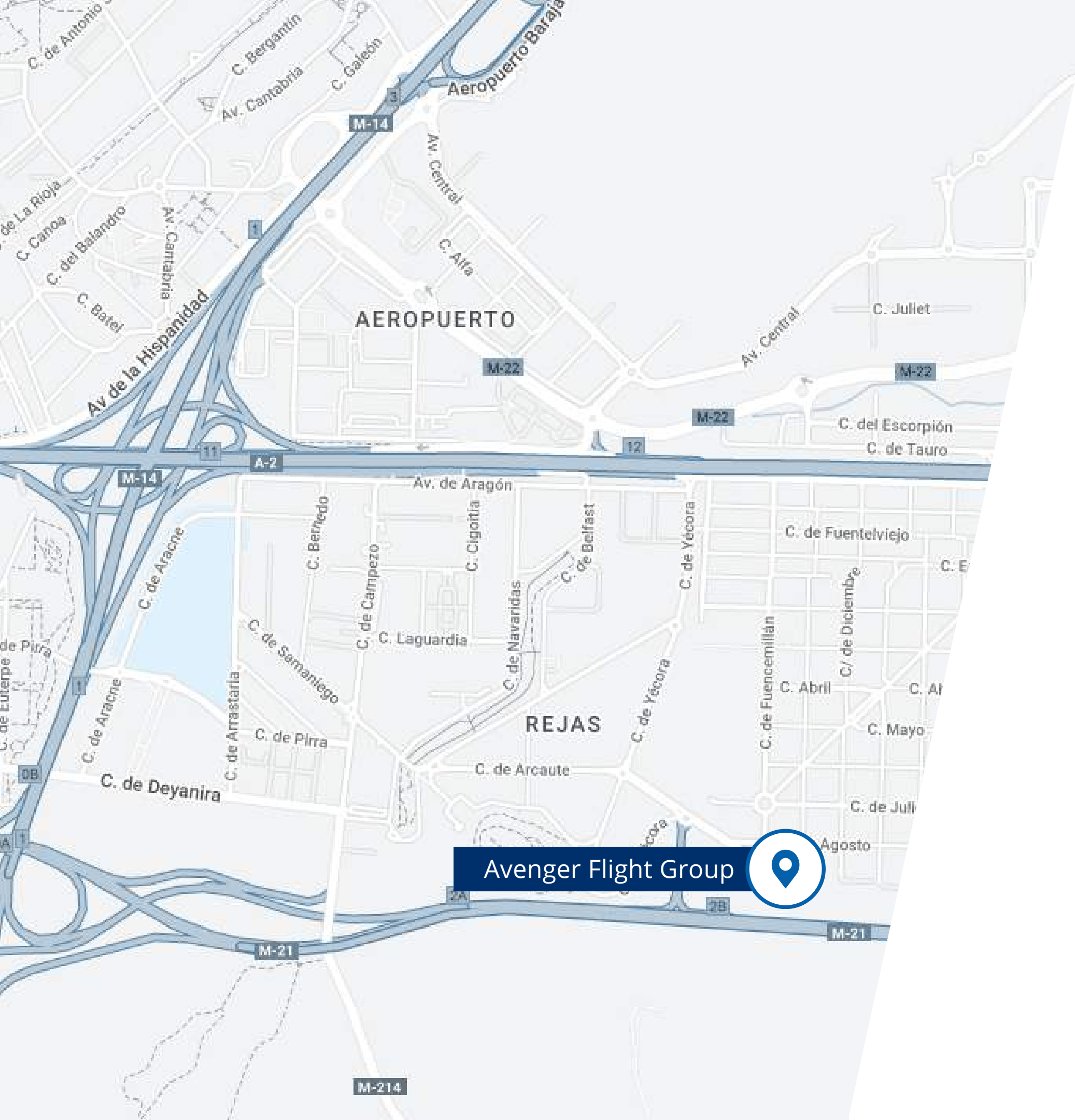

Lunch Ideas



Restaurant La Abuela | Calle de Febrero, 37, 28022 Madrid.
7 min walk from the Training Center, 2 min. by car.
Restaurant that serves delicious homemade food, there you can have lunch for only €9 (Menú del día), which includes starter, main course, one drink, desert and coffee.



Restaurant La Bandeja | C. de Agosto1, 28022 Madrid.
(inside Vim Padel center premises) 2 min walk from the Training Center. Restaurant offers mediterranean fusión cuisine including breakfast, lunch, dinner, coffee and snacks. Opens from 09:00h to 01:00h.



Restaurant Los Fogones | Calle Arcaute, 15, 28022 Madrid.
6 min. walk or 2 min. by car. Homemade food, Menú del día €12 which includes starter, main course, one drink, dessert and coffee.



Hokkaido Sushi Madrid | C. de Arcaute 23, 28022 Madrid.
8 min walk or 2 min drive from the Training Center.
Restaurant offers traditional Japanese food available for lunch. Open from 12:00h to 23:45h.



Shopping Mall "Plenilunio" | Calle Aracne, 28022 Madrid.
15 min walk or 5 min by car. On the last floor of the shopping mall you can find a great variety of restaurants (Fast food, Asian and Italian cuisines, Brasserie, Sushi, etc.)



Also you can use **delivery services** as *Just Eat*, *Uber Eats* or *Glovo* if you want your lunch to be delivered to the TC.



Best restaurants



Casa Salvador (€€) | Calle de Barbieri, 12, 28004 Madrid

An outstanding and small bullfighting tavern that was founded by in 1941. The walls pay tribute to Spain history. The broadly appealing menu features dishes like traditional oxtail stew and fried hake.



Raimunda (€€) | Paseo Recoletos 2 Palacio de Linares, 28001 Madrid

Bohemian restaurant, surrounded by vegetation and with indoor and outdoor areas, which prepares unique dishes that mix Ibero-American cuisine..



Sobrino de Botín (€€€) | Calle de los Cuchilleros 17, 28005 Madrid Founded in 1725, it is the oldest restaurant in the world in continuous operation, according to the Guinness Book of Records.

Their signature dishes are cochinillo asado and sopa de ajo.



Most restaurants in Spain work with previous reservation

General working hours of restaurants in Spain:

13.30 PM - 16.30 PM

20.00 PM - 22.30 PM

Hotel Accommodations

AFG has fixed negotiated rates with four hotels that are located close to the Training Center

Hotel Nuevo Boston | Avenida de Aragón 332, 2822 Madrid

- Double room (1 guest) with breakfast (Sun-Thu €99 + 10% VAT/night; Fri-Sat & blackout dates €120 + 10% VAT/night)
- Double room (2 guests) with breakfast (Sun-Thu €121 + 10% VAT/night; Fri-Sat & blackout dates €144 + 10% VAT/night)
- Shuttle Airport-Hotel included.

Madrid Marriott Auditorium Hotel | Av. de Aragón, 400, 28022 Madrid (Parking and Shuttle from/ to the Airport included)

- Double room (1 guest) with breakfast (€116 + 10% VAT/night)
- Double room (2 guests) with breakfast (€136 + 10% VAT/night)
- Shuttle Airport-Hotel included.



If you want AFG to help you with accommodation in Madrid, please contact us 2 days prior to your arrival



Hotel Accommodations

AFG has fixed negotiated rates with four hotels that are located close to the Training Center

Axor Feria Hotel | C. de Campezo, 4, 28022 Madrid

(Shuttle included from/ to the airport and to the Training Center)

- Double room (1 guest) with breakfast (€122.73 + 10% VAT/night)
- Double room (2 guests) with breakfast (€137.73 + 10% VAT/night)
- Shuttle Airport-Hotel included.

Axor Barajas Hotel | C. de Campezo, 4, 28022 Madrid

(Shuttle included from/ to the airport and to the Training Center)

- Double room (1 guest) with breakfast (€131.82 + 10% VAT/night)
- Double room (2 guests) with breakfast (€146.82 + 10% VAT/night)
- Shuttle Airport-Hotel included.



If you want AFG to help you with accommodation in Madrid, please contact us 2 days prior to your arrival



Best Hotels in the City Center

Hotel Emperador | C/ Gran Vía, 53, 28013 Madrid

Riu Plaza España | C/ Gran Vía, 84, 28013 Madrid

Hotel Fenix Gran Meliá | C. de Hermosilla, 2, 28001 Madrid

Hotel Palacio de los Duques Gran Meliá | Cuesta de Sto. Domingo, 5, 28013 Madrid



If you want AFG to help you with accommodation in Madrid, please contact us 2 days prior to your arrival



Other Options & Attractions



Apartamentos Suites Aeropuerto | C. de Campezo, 8, 28022 Madrid
1- or 2- bedrooms apartments available for weeks or months, good option if you are staying in Madrid for a long period of time, located close to the Training Center, swimming pool and gym are available.

Plaza Mayor | Pl. Mayor, 28012 Madrid



Puerta del Sol | Prta del Sol, 28013 Madrid

Retiro Park | C. de Alfonso XII, 18, 28014 Madrid

Gran Vía | C/ Gran Vía, 28013 Madrid

Royal Palace | C. de Bailén, s/n, 28071 Madrid



El Jardín de Diana

C/ Gran Vía, 31, Planta 10, 28013
Madrid

Hotel Riu Plaza España

C/ Gran Vía, 84, 28013 Madrid

Apartosuites Jardines de Sabatini

Cta. de San Vicente, 16, 28008
Madrid

Azotea Círculo de Bellas Artes

C. del Marqués de Casa Riera, 2,
28004 Madrid



Contact info



Reception Number: (+34) 911-23-41-21

From 5 PM till 8 AM. Please, call this number to access the Training Center



Emergency Phone 24/7

Alejandra Miranda TC Manager
Tel **(+34) 911-23-41-21** Ext. **702**
Cel **(+34) 620-47-01-07**



Email

info@afgsim.com



Address

C. del Almanaque, 5,
28022 Madrid



Madrid Telephone Numbers



TOURIST INFORMATION

Madrid City Tourist Office

Plaza Mayor, 3

(+34) 915-882-900 / (+34) 913-665-477

www.munimadrid.es

Spanish National Tourist Office

(+34) 915 787 810

Airport Tourist Office

(+34) 913-338-247



POLICE

National Police Number 091

Municipal Police 092

Lost items 010



EMERGENCIES

National telephone number 112



HEALTH

Urgencies 061

Fire Station 080 or 085

Health emergency number 061



TAXIS

Radio Taxi (+34) 915-47-85-00



#MiCasaEsSuCasa